

istruzioni per l'uso
operating instructions
Bedienungsanleitung
instrucciones de
manejo
mode d'emploi
gebruiksaanwijzing

A01607270 Astro 600W 6000K Tropical

DMX512+RDM

K01607270 Astro 600W 6000K kit Tropical

DMX512+RDM

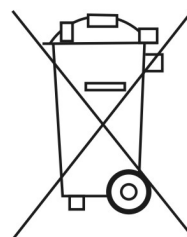

ENGLISH – TABLE OF CONTENTS

1.Important safety norms	page 2
2.Warning on COB-source luminaires.....	page 4
3.Box content.....	page 5
4.Weight and dimensions.....	page 6
5.Mounting the spigot.....	page 6
6.Mounting the colour changer	page 6
7.Mounting / replacing the iris diaphragm	page 7
8.Gobo holder	page 7
9.Adjusting the yoke	page 8
10.Important notice before the installation/installation.....	page 8
11.Wiring	page 8
12.Voltage	page 9
13.Frequency.....	page 9
14.Connect to the power supply.....	page 9
15.Mechanical operation.....	page 9
16.Local Control panel and operation.....	page 10
17.Menu	page 10
17.1 DMX or manual	page 10
17.2 DMX address	page 10
17.3 Dimmer Resolution	page 11
17.4 Lost DMX Signal	page 11
17.5 Strobe	page 11
17.6 Strobe Speed	page 11
17.7 Dimming curve	page 12
17.8 Cut off dimming response	page 12
17.9 Dimming behaviour	page 12
17.10 LCD Screen Illumination	page 13
17.11 Temperature Control(TBoard)	page 13
17.12 Temperature Control(Tled)	page 13
17.13 Software Version	page 13
17.14 Manual Dimmer Type	page 13
17.15 Pro or Basic Control	page 14
17.16 Factory Settings	page 14
17.17 ID for REMOTO	page 14
17.18 Calibration	page 14
17.19 Exit Hidden Menu	page 14
18.Cleaning and maintenance.....	page 15
19. Spare parts.....	page 15
20. Warranty.....	page 15
21. Available accessories	page 15
22. Summary of Controls and functions.....	page 17
23. DMX charts.....	page 18
23.1 DMX chart 1.....	page 18
23.2 DMX chart 2.....	page 18
23.3 DMX chart 3.....	page 18
23.4 DMX chart 4.....	page 19
LDR Conformity Certificate – Certificato di Conformità – Konformitätserklärung	page 20
Complaint form – Modulo di reclamo – Reklamationsformular	page 21
WEEE Directive – Direttiva RAEE – WEEE Richtlinie	page 22

ENGLISH

Thank you for choosing a quality product from Luci della Ribalta srl. We trust our products and services meet your requirements, but if not please contact us directly using the attached feedback form to help us improve our service quality.

This product has been manufactured with great care and left our factory in perfect conditions, but if it has been damaged in transport please contact your dealer in the first instance. A feedback form is appended. Our warranty covers all manufacturing and component defects for 2 years from the date you purchased the product.

Our products are designed for the use of professional technicians and operators only, and the instructions provided here ensure a safe and correct operation of this product. Luci della Ribalta srl will not accept any responsibility where damage has been caused to the product or persons through improper use of the product and/or non-compliance with the regulations described herein.

IMPORTANT: Read these user instructions before using this lighting unit

The instructions given here ensure a safe and correct usage of this product. A user's failure to comply with the installation, operating, maintenance and safety procedures mentioned in this manual, as well as those generally applicable to this lighting equipment, may cause the unit not to perform as expected.

Luci della Ribalta accepts no liability for direct, indirect, incidental, special, or consequential damages resulting from the customer's failure to follow the installation, operating, maintenance and safety procedures in this manual or those generally applicable to lighting equipment.

The limitation extends to damages for personal injury, property damage, loss of operations, loss of profits, loss of product or loss of time, whether incurred in by the customer, the customer's employees or a third party.

Apart from the instructions given on this manual, all relevant safety and health standards of the appropriate Directives of the country where the unit will be installed must be complied with.

1. IMPORTANT SAFETY NORMS

- This product is a professional lighting fixture, namely a followspot, fitted with a LED light source, which can only be operated by professional staff
- Warning, high voltage ignition. Disconnect the unit from power before servicing
- Continuous mains power is required for this spotlight as an internal dimmer controls the intensity via DMX or local rotary knob. An accessory clamp-on digital dimmer, for positioning on the side grab handles of the followspot, is furthermore supplied to locally control the dimming
- Use of a phase control dimmed mains supply may damage the internal electronics
- This product features fan-assisted ventilation. Make sure you do not cover the fans or obstruct the air flow at any time
- Make sure all fans are working correctly at any one time. Should you detect even the slightest malfunction, switch the luminaire off and carry out the necessary servicing. Replace the fans if necessary

- This product is rated IP 20 and is therefore designed for interior use only. For details on maximum ambient temperature and tilt angle please refer to what indicated on the product label or screen-printing on the side of the lens-tube or the rear of the LED-house
- Repairing and replacement of any component of this product must be carried out exclusively by professional personnel in conformity with the relevant safety and health standards and only with original Luci della Ribalta srl components
- Replacement of any part of the wiring system must be carried out exclusively by professional personnel in compliance with the original wiring diagram and with components identical to or compatible with those originally fitted
- Installation of this product must be exclusively carried out by professional personnel in compliance with the safety norms in force in the country where the product is used



**WARNING: DANGER OF ELECTRICAL SHOCK
DO NOT OPERATE ON LIVE EQUIPMENT**

- Disconnect power before opening this fixture to access its light source or electronics.
- The replacement of the LED source or any of its electronic components can be carried out exclusively by professional personnel upon LDR's written authorization and only with original Luci della Ribalta srl components. Failure to obtain the manufacturer's authorization to carry out the replacement/repair, will immediately invalidate the product's warranty



WARNING: EYE DAMAGE HAZARD

Make sure this fixture is installed so as to avoid prolonged direct staring at its operating light source (LED) from a distance of less than 7m / 23ft.



WARNING: FIRE HAZARD

- Never locate this fixture on any flammable surface.
- Minimum distance of any part of the body of the luminaire from any flammable surface or object: 0,5m / 20in
- Minimum distance from lit surface, please refer to product label
- Make sure the mains power supply the fixture will be connected to is protected by a suitable thermal magnetic circuit breaker

2. **WARNING ON COB-SOURCE LUMINAIRES: CORRECT HANDLING, INSTALLATION AND MAINTENANCE**

LED-source luminaires need special care when choosing where to install them as the COB is a very sophisticated piece of electronics, which is very sensitive to natural or chemical air pollutants or dust of any origin. When the installation of the Astro 600 in venues where fog or haze machines are also being used or wherever air pollution of any sort cannot be avoided please be aware that the COB might suffer fatal damages which might dramatically shorten its life or reduce its performance.

NOTE: We manufacture a **TROPICAL** version of the ASTRO 600, which, apart from protecting the electronics from damp and humidity also grants a longer-lasting protection against damages from air-pollutants.

Contact a certified LDR distributor in case of residuals or other objects located on the surface of the LED source or whenever a COB becomes damaged for any reason.

CAUTION: DO NOT ATTEMPT TO CLEAN IT IN ANY WAY

As general rules please consider the following:

- do not touch the surface of the LED source
- do not rub it
- do not put mechanical stress on the COB especially on the resin area. It may cause LED light to stop functioning
- do not expose the COB to direct compressed-air flux
- ensure that no objects attach or put pressure on the resin area

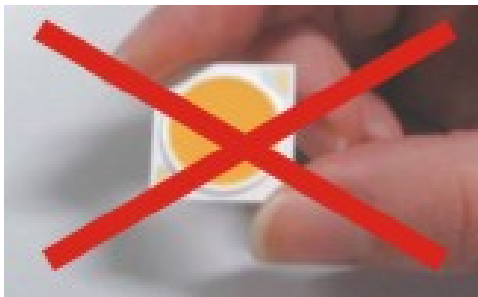

- do not use sharp objects like tweezers to pick up or hold LED packages. The wire inside the resin area may disconnect, thus causing the light to stop functioning



The resin area includes both the light emitting area and the white dam area.

- avoid anything sharp to press, put stress on, rub, attach or make contact with the resin as this might negatively affect the function, performance and reliability of this product.



The COB contains silicone to protect the LED dies and the silicone is gas permeable. Some VOCs (Volatile Organic Compound) and chemicals will cause discoloration, surface damage, cracking or erosion. Here below the list of harmful materials which will damage the silicone. Please do not use them together with the LED package. If it is necessary to use them together, please test them before use.

- acetic acid
- ammonia
- benzene
- castor oil
- dichloromethane
- gasoline
- halogenated hydrocarbons (containing F, Cl, Br elements)
- hydrochloric acid / hypochlorous acid
- lard
- linseed oil
- MEK (Methyl Ethyl Ketone)
- MIBK (Methyl Isobutyl Ketone)
- mineral spirits
- nitric acid
- petroleum
- potassium hydroxide / potassium hypohydrite
- rosin flux
- silicone oil
- sodium hydroxide / sodium hypohydrite
- sulfuric acid
- tetrachloromethane
- toluene
- xylene

3. BOX CONTENT

A. Standard followspot

Astro followspot in the chosen model
Separate 6-colour colour changer unit

B. Kit followspot

Astro f.spot in the chosen model in flight case
Separate 6-colour colour changer unit

Mains power cable with Power-Con
Fitted Ø28mm/1.12in spigot with fluid head
Fitted iris diaphragm
Mobile clamp-on dimmer

Mains power cable with Power-Con
Separate Ø28mm/1.12in spigot with fluid head
Fitted iris diaphragm
Mobile clamp-on dimmer
Black followspot tripod

4. WEIGHT AND DIMENSIONS

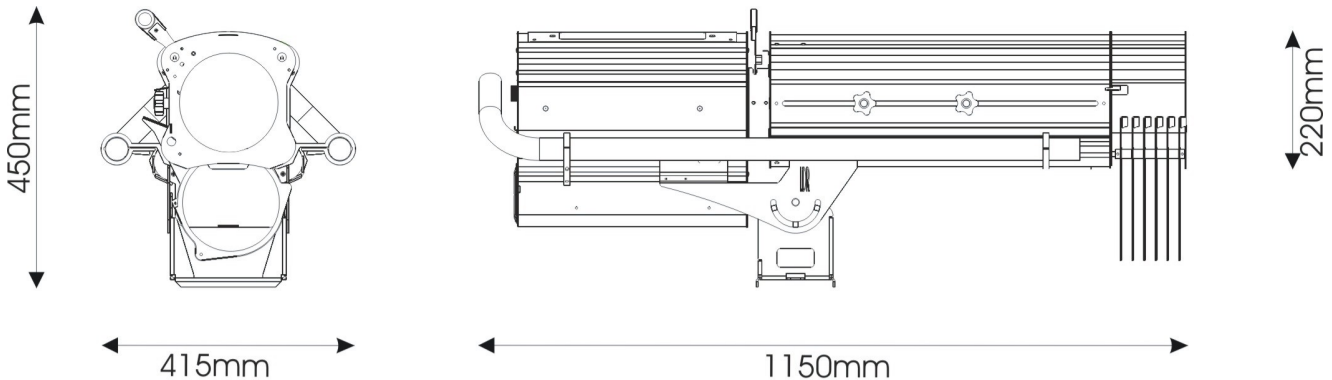

ASTRO 600 3200K and 6000K

net weight: 31 kg + 1,2 kg colour changer

gross weight: 36 kg

packing dimensions: 1x 115x46x46h cm + 2x 31x26x15h cm (spigot with fluid head + colour changer)

5. MOUNTING THE SPIGOT - # A20102100

This product is a followspot meant for tripod- or pole-mounting only and is therefore not fitted with any secondary fixing point. Do not hang it.

A Ø28mm/1.12in spigot with fluid-head is supplied in standard delivery for you to tripod-mount your. To mount the spigot please refer to the relevant instruction manual supplied with this part (separate box)

6. MOUNTING THE COLOUR CHANGER (supplied, part nr. 20105206)

The Astro 600 comes with a 6-colour colour changer unit which is packed separately in an outer box or in the flight case and needs to be fitted to the lens-tube of your followspot as follows:

- Mount the colour filters on the colour changer units. See relevant instructions supplied with the colour changer
- At the front of the followspot, slacken the 3 cross-head black M4 screws (two at the top angles, one at the bottom, left-hand side angle) so that they remain inserted approximately half-way through
- Position the colour changer unit on the front plate of the followspot, making sure that the colour levers are positioned on the left-hand side of the follow spot when viewed from the front and hang it to the previously positioned screws

- Release the colour filters of the colour changer by pressing the black, flat lever in order to have access to the screws
- Insert a M4 Phillips screws driver at least 12cm long in each one of the holes provided at the front of the colour changer and tighten each screw
- Ensure the colour changer unit is secure, and all three screws are tight

7. MOUNTING / REPLACING THE IRIS DIAPHRAGM - supplied

The iris diaphragm supplied with the followspot has 20 leaves to size the beam from a maximum aperture of 68mm/2.67in to a minimum of 5mm/0.19in. The iris comes already fitted, so you will only have to refer to this section in case you need to remove or replace the iris.

- Using a Phillips screw-driver (M3) remove the cross-head screws from the top lids of the gate area (2 lids, 2 screws each)
- Using a Phillips screw-driver (M4) remove the two cross-head screws from the sides of the iris plate
- By pulling (to remove) or pushing (to insert) from the lever handle, slide the iris diaphragm out / in the gate area
- Fix the iris in position by tightening the previously removed screws
- Re-position the top lids and fix the M3 screws

Important notice: do not leave the iris totally closed for over 5 minutes while the LED is on

FAILURE TO COMPLY WITH THE ABOVE NOTICE MAY CAUSE THE IRIS AND THE FOLLOWSPOT TO SUFFER MAJOR HEAT DAMAGES AND WILL INVALIDATE THE PRODUCT WARRANTY

8. GOBO HOLDER (accessory, part nr. A20100808)

The gate area of the ASTRO 600 can accommodate a gobo holder for B-size metal gobos. The gobo-holder sits in front of the iris diaphragm and they can be used simultaneously. The gobo-holder is not part of the standard delivery and must be ordered separately.

In order to fit the gobo holder:

- Using a Phillips screw-driver (M3) remove the cross-head screws from the top lids of the gate area (2 lids, 2 screws each)
- Remove the two M4 screws fitted to each side of the gobo holder
- By pushing from the lever handle, slide the gobo-holder in the gate area. The bent top-lid of the gobo holder must overlook the inner part of the gate area
- Fix the gobo-holder in position by tightening the previously removed screws
- Re-position the top lids and fix the M3 screws

9. ADJUSTING THE YOKE

This followspot is provided with a yoke balancing adjustment. The balancing point is factory set for the standard product configuration supplied (with 6-colour colour changer). However, should you need to adjust the balancing, please follow the procedure here below:

- The followspot must be mounted on the tripod stand with all relevant accessories attached
- Using a Phillips screw driver, slightly loosen the 2 M5 screws on each side of the yoke
- Gently slide the followspot backwards or forwards to the required position by using both hands. Make sure you always hold the followspot with at least one hand to prevent the heavy LEDhouse to suddenly bend downwards
- Make sure the yoke is correctly aligned horizontally
- Lock the tilt-lever
- Tighten the 4 M5 screws

10. IMPORTANT NOTICE BEFORE THE INSTALLATION / INSTALLATION

This fixture is meant for tripod-mount installation only. No hanging is allowed
Before installing this fixture check its weight on the product label and the weight of each accessory you are adding and make sure the structure you are installing it to withstands the total weight.
The mounting stirrup is designed to allow the spotlight to be fitted to a suitable tripod or pole.

CAUTION

DO NOT TURN THE LUMINAIRE UPSIDE-DOWN AND MAKE SURE THE STIRRUP ALWAYS SITS DOWNWARDS

Note: the fixture's location must provide suitable ventilation for the LED module.

11. WIRING

Before being connected to the mains power, this unit may need to be wired with a suitable plug if not already installed. Make sure the plug you are using is rated for the product's power load.

This fixture must be grounded

Ensure the plug conforms to the relevant EU/UL or local electrical standards

To perform a correct wiring, please note that the cores in this mains lead are colour-coded as follows:

Ground: green+yellow – Neutral: blue - Phase: brown

In case the colours of the wires do not correspond to the colour of the connection points on your plug, please proceed as follows:

- The green or green and yellow wire must be connected to the connection point marked with the letter E or with the symbol  or coloured in green or in green-yellow
- The blue wire must be connected to the connection point marked with the letter N or coloured in black
- The brown wire must be connected to the connection point marked with the letter L or coloured in red

Before you finally position this product for use, temporarily connect it to a properly fused power supply to check the unit works correctly.

12. VOLTAGE

Before operating this unit please refer to the product label mounted at the back of the luminaire to check you are operating with the correct voltage. The Astro 600 LED can be operated between 100V and 260 VAC.

13. FREQUENCY

Frequency on this product is automatically selected by the electronic PSU (50/60Hz).

14. CONNECT TO THE POWER SUPPLY

- Connect the unit to a continuous mains power source
- Make sure the power supply is protected by a suitable thermal magnetic circuit breaker
- This fixture must be grounded

15. MECHANICAL OPERATION

Focus control: this fixture features a variable beam angle from 7° to 12° which can be controlled through the two control knobs on the right-hand side of the lens-tube.

The variable beam is modified by adjusting the front and rear zoom lenses in relation to each other. The front lens defines the beam spread, the rear lens defines the focus degree of 'softness' or 'hardness' of the beam edge or shutters.

Gently turn the knobs anti-clockwise until you have reached the desired size/focus of the beam in relation to the distance you are projecting at.

Turn the knobs clockwise and tightly close them so that the lenses are held in position at any tilt angle

Beam-sizing: the size of the beam is controlled using the supplied iris diaphragm

Beam-dimming and black-out: this followspot can be dimmed and backed-outby:

- Local manual control, rotary switch on the backplate of the unit
- Local, via clamp-on digital dimmer, supplied – see relevant instructions
- Remote, by DMX512 signal

CAUTION: Make sure you always use the one of the above options to black-out the light and never the sizing iris diaphragm as keeping the latter closed may cause overheating, damage and even fire inside the LED-house.

Pan & Tilt control: this unit is fitted with 2 soft, comfortable side bars covering the full length of the followspot for an easy and safe control of the pan and tilt angle by the followspot's operator from any position

The stirrup is factory-balanced and fitted with a positive friction clamp controlled by a user-friendly, effective lever-knob. Turn the knob anticlockwise to release it, position the followspot at the desired tilt angle and turn the knob clockwise to hold the desired position.

Press the button at the top of the lever and keep it pressed while turning the lever if you need to change its position.

Make sure the knob is softly tightened at any time during operation

16. LOCAL CONTROL PANEL AND OPERATION

OPERATION: LCD display for DMX address, system setup and status details.

POWER: power LED status indicator, red colour. ON= power

DMX: DMX LED status indicator, green colour. LED OFF = DMX OFF and manual control activated, LED ON = DMX MODE activated with no DMX signal, FLASHING LED = receiving DMX

MENU: rotary switch selector to select and modify the operational modes. Turn left or right to navigate through the menu and press to select or to confirm

DMX IN: input DMX signal (pin1=0, pin2= DATA-, pin3=DATA+).

DMX OUT: Loop through DMX signal output

POWER IN: Mains power input

POWER OUT: Mains power output

17. MENU

There are fourteen different menus to control the settings of the ASTRO 600W LED. The rotary selector is used to adjust the settings and to navigate through the menu. Turn left or right to select the menu and push to access or to confirm the selected data or functions. To exit the selected menus without saving the data, press the rotary selector for at least 1 second.

17.1 DMX OR MANUAL (Mode)

Select the LED control mode between DMX (factory setting) and manual. To change the control mode press once the rotary selector until an arrow (←) appears on the menu. Turn the selector to the right or the left to select the desired mode of operation and press to confirm your selection.

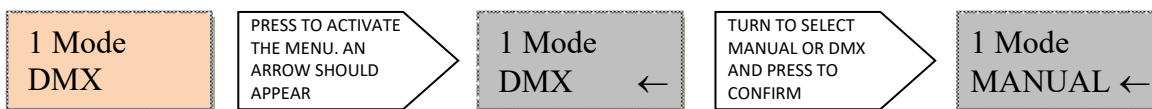

Tap the rotary selector and the LCD screen will display the mode status and the current value:

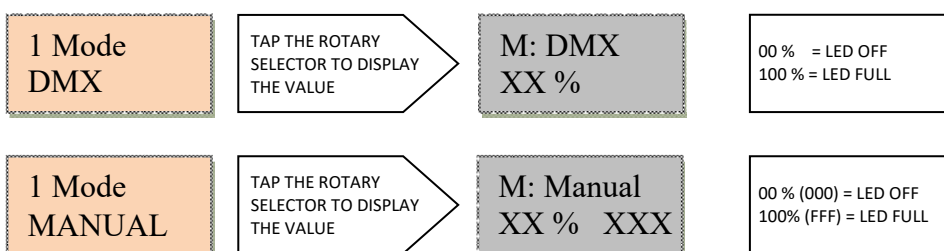

17.2 DMX ADDRESS (Addr)

It allows to select the initial DMX starting address to remotely control the LED functions. To change the initial DMX address press the rotary switch until an arrow appears, then turn to change to the desired DMX starting address. Press to confirm your selection.

Factory setting is 001.

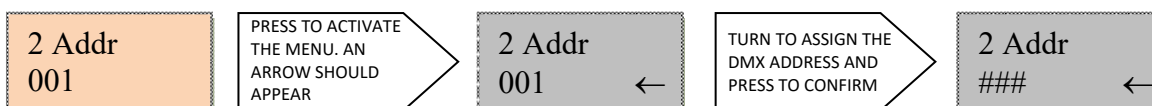

17.3 DIMMER RESOLUTION (8/16b)

The dimming resolution can be controlled at 8 bits from one DMX channel to 16 bits with 2 DMX channels.

Factory setting is 8 Bit.

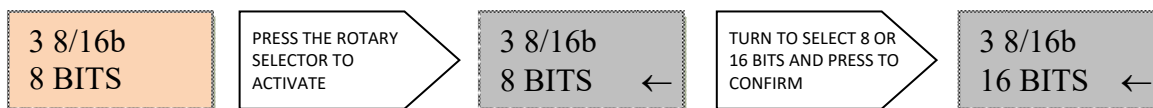

17.4 LOST DMX SIGNAL (DMXMem)

In case of signal failure this function allows to store in memory the last DMX value.

Factory setting is ON. Three options are available:

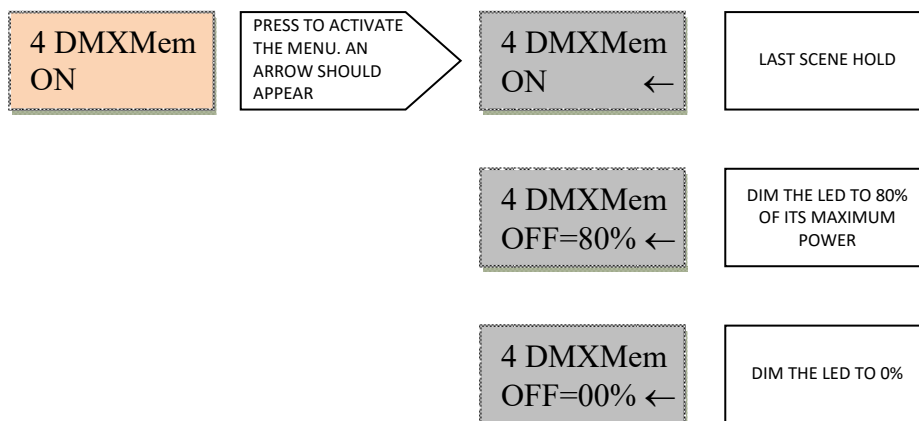

17.5 STROBE (Strobe)

This function enables to activate the strobe function. Factory setting is DISABLE.

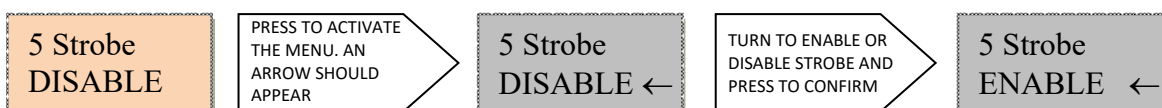

17.6 STROBE SPEED (SetStr)

It allows to set the strobe speed. This menu is not active when the strobe function is disabled or when it is remotely controlled through DMX. Factory setting is OPEN.

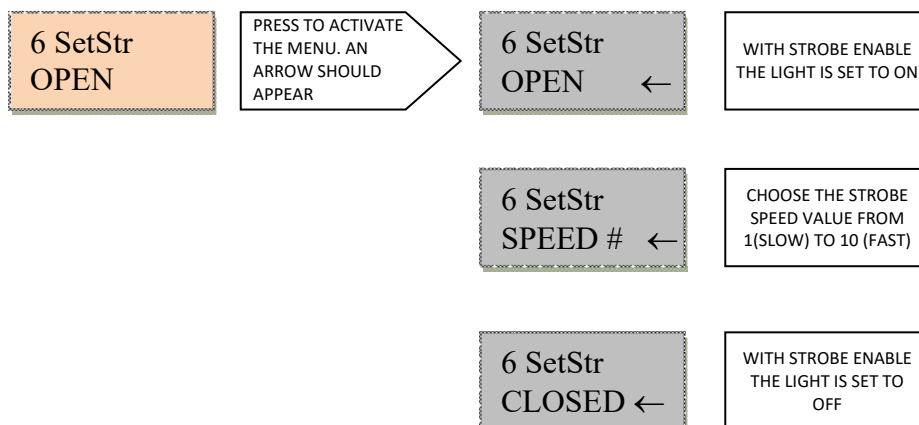

17.7 DIMMING CURVE (Curves)

This function allows to select a response curve for the Astro LED. A choice of two curves is available: Square and Linear. Factory setting is SQUARE.

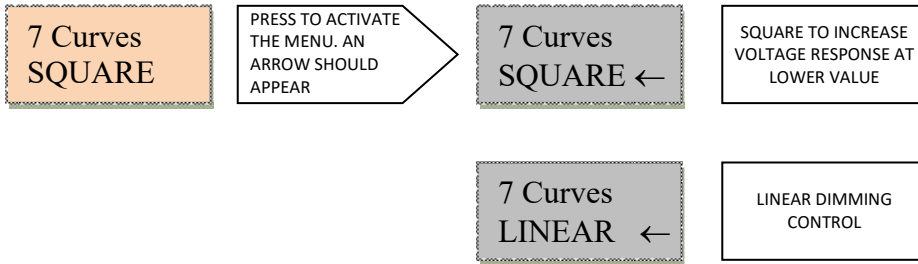

17.8 CUT OFF DIMMING RESPONSE (CutOff)

This function allows to select a LED behaviour simulating a tungsten or halogen lamp during the dimming cut off.

Factory setting is SLOW.

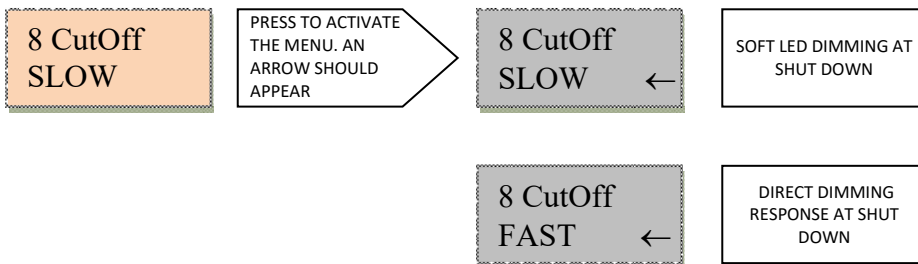

17.9 DIMMING BEHAVIOUR (Smooth)

This function allows to set the LED dimming response. Factory setting is NORMAL.

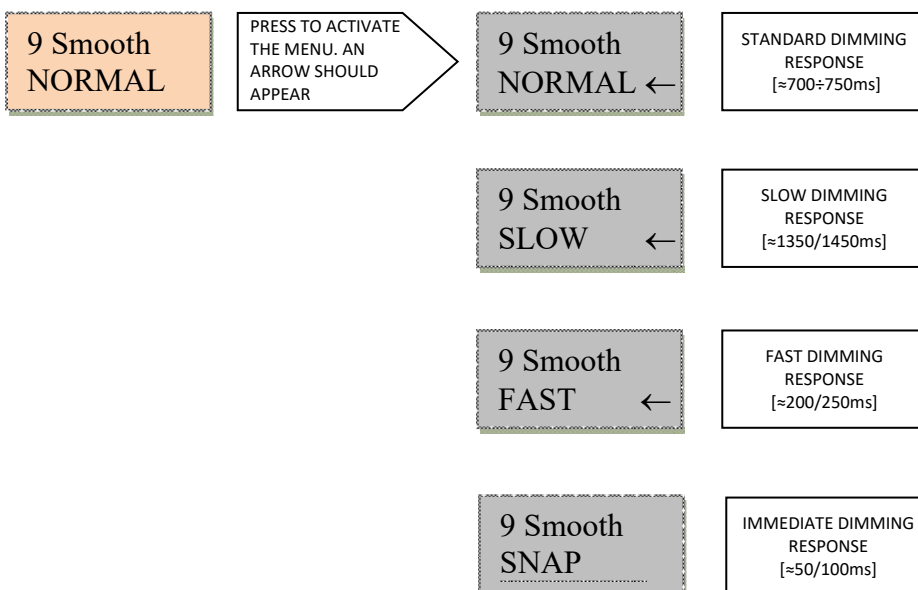

17.10 LCD SCREEN ILLUMINATION (BackL)

This function allows to turn off the LCD backlight, the LED POWER and LED DMX after 1'30" from the last setting. Factory setting is AutoOFF.

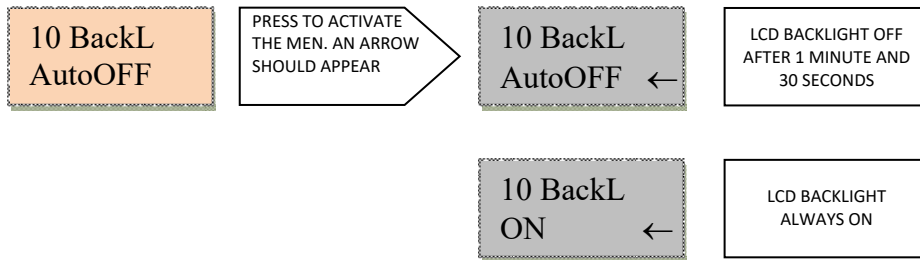

17.11 TEMPERATURE CONTROL (TBoard)

This function allows to visualize the Board temperature. Factory setting is °C.

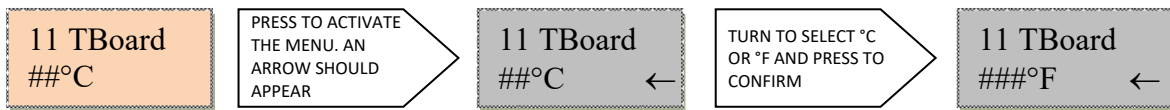

17.12 TEMPERATURE CONTROL (Tled)

This function allows to visualize the LED temperature. Factory setting is °C.

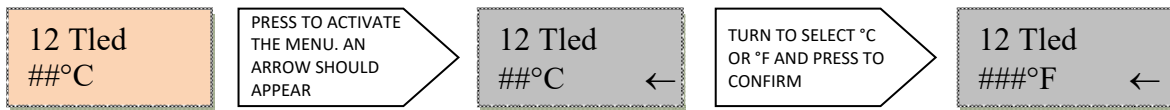

17.13 SOFTWARE VERSION (SwVer)

This function allows to visualize the software version.

17.14 MANUAL DIMMER TYPE (Manu)

This function allows to select the manual dimmer type. The Astro 600 is supplied with a mobile clamp-on digital dimmer which can be clamped-on in any position of each of the side control bars and needs to be set as follows.

Factory setting is ENCODER.

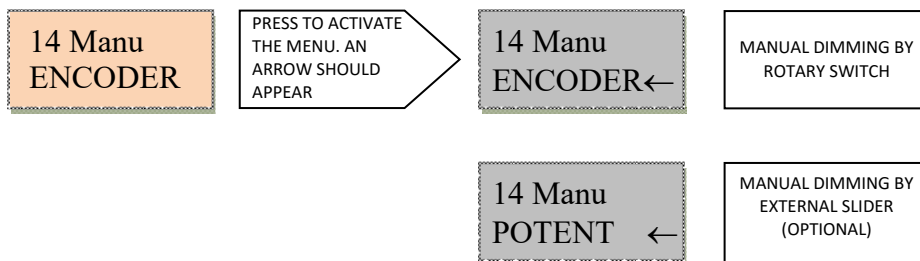

HIDDEN MENUS

There are also four different hidden menus to select the advanced settings of the ASTRO LED. To activate this function turn the Astro OFF and then ON again by pressing the rotary switch at power on.

17.15-A PRO or BASIC CONTROL (ProBasic)

The PRO-BASIC control is a special function which allows to limit the access to the control menu. Select ProBasic with the rotary switch and press to access the menu.

Select:

- PRO, to enable access to all the functions
- BASIC, to limit the access to functions 17.1 DMX or MANUAL MODE, 17.2 DMX ADDRESS, 17.11-17.12 Temperature Control and 17.13 Software version.

Factory setting is PRO.

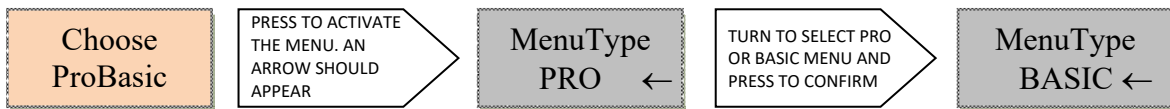

17.16-B FACTORY SETTINGS (Reset)

The RESET control is a special function which allows to RESET the product to factory settings.

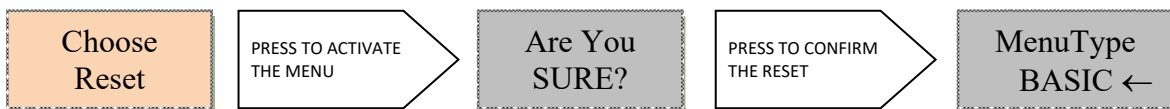

17.17-C ID REMOTO (ID Rem)

It allows to select the ID number to connect the Astro to Remoto (available as a separate accessory under part # A20702072) a device which allows to upload and download firmware. To change the initial ID press the rotary switch until an arrow appears, then turn to change to the desired ID number. Press to confirm your selection. It is possible to select an ID number from 0 to 250. If ID number=0 remote control is not active.

Factory setting is 000.

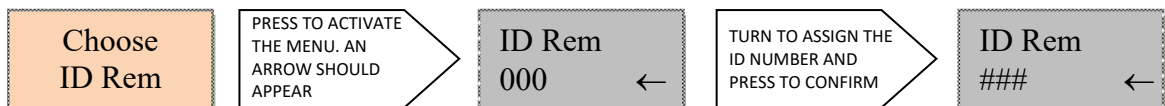

17.18-D CALIBRATION (Set Min)

It allows to calibrate the minimum level of the output.



17.19-E EXIT HIDDEN MENU (Exit)

It allows to exit from the hidden menus.

18. CLEANING AND MAINTENANCE

To ensure maximum performance of the product, a regular maintenance service should be carried out. Please make sure the product is cold and disconnected from power supply when doing this.

General maintenance

- * Clean all reflective parts such as lenses opening the product, if necessary.
- * Check the lenses and replace any visibly damaged component.
- * Clean air ducts and fans in order to allow proper ventilation activity on the product.
- * Check internal and external wiring and replace any cable which should be damaged by heat or mechanical agents.

Cleaning of optical components

LEDhouse lenses:

- Open the lens compartment lid by removing the two M4 cross head screws at the rear of the led-house tube and slide the top lid free
- Remove the condensor lenses assembled block by removing the two M5 cross head screws.
- Clean the lenses with a soft cloth and re-position

Zoom lenses:

Slide the front zoom panels positioned at the bottom of the lens tube and clean with a soft cloth.

19. SPARE PARTS

All components are available as spare parts. We strongly recommend you always use original LDR components as spare parts. Please refer to our technical assistance should you need to order and/or replace any part of the unit.

20. WARRANTY

Our warranty covers all structural and manufacture defects for two years from the date you purchased this product. In case of complaints we strongly recommend you use the complaint form at the end of this manual or contact the local dealer who supplied the product to you. In any case please report the serial number of the product.

In case of complaints under warranty proof of purchase will have to be provided.

21. AVAILABLE ACCESSORIES

A20100106	185x185mm colour frame
A20109106	Kit 185x185mm colour frame + front runners
A20105106	5-colour colour changer magazine
A20105206	6-colour colour changer magazine
A20100707	Spare iris diaphragm
A20100808	B-size gobo holder for metal gobos
A20102100	Spare fluid-head spigot for followspot tripod
A20102200	Spigot for tripod
A20102311	HD steel tripod with fluid head
A20102401	Black followspot tripod

A20102402	Chrome-plated followspot tripod
A20107180	Flight-case with braking wheels, stackable
A20202401	Set of 3 braking wheels for followspot tripod
A20702071	Side-handle clamp-on digital dimmer
A20702072	Remoto control unit for software upgrade
V90MLRT100FR	Braking wheel (1pc) for flight case

22. SUMMARY OF CONTROLS AND FUNCTIONS

#	Function	Description	Available Options	Factory Setting
1	Mode	MANUAL or DMX control	MANUAL (controlled from the rotary switch or slider); DMX	DMX
2	Addr	Selects the DMX starting address; other remotely controlled functions are assigned in sequence to the 1st assigned DMX address	From 001 to 512	001
3	8/16b	8 or 16 Bits dimming resolution	8 BITS on 1 channel; 16 BITS on 2 channels	8 BITS
4	DMXMem	Sets the behaviour of the unit in case of DMX failure	ON = last DMX value; OFF=80% fade to 80% after 1,5 Sec; OFF=0%	ON
5	Strobe	Activates the Strobe function	ENABLE ; DISABLE	DISABLE
6	SetStr	Selects the Strobe speed. This menu is inactive when the Strobe function is disabled or when remotely controlled through DMX	OPEN = ON ; SPEED = ## (select value from 01 slowest to 10 fastest); CLOSED = OFF	OPEN
7	Curves	Selects the dimming curve	SQUARE ; LINEAR	SQUARE
8	CutOff	Replicates the halogen lamp dimming behaviour at cut off	FAST = NOT ACTIVE ; SLOW = ACTIVE	SLOW
9	Smooth	Dimmer response	NORMAL = 700ms ; SLOW = 1400ms FAST = 200ms ; SNAP = Immediate response	NORMAL
10	BackL	LCD screen retro-illumination	ON ; AutoOFF = LCD light off after 1'30"	AutoOff
11	TBoard	Visualizes the Board temperature	Selects the LED Temp in °C or F°	°C
12	Tled	Visualizes the LED temperature	Selects the LED Temp in °C or F°	°C
13	SwVer	Visualizes the software version		---
14	Manu	Selects the manual dimmer type	ENCODER = Rotary switch POTENT = External slider	ENCODER

SPECIAL FUNCTIONS: to activate these functions press the rotary switch at power on				
#	Function	Description	Available Options	Factory Setting
A	ProBasic	Sets the functions available from the control menu	PRO = Enables access to all functions; BASIC = Limits the access to: 1 Mode, 2 Addr, 11 TBoard, 12 Tled and 13 SwVer	PRO
B	RESET	Factory RESET	Returns to factory settings	---
C	ID Rem	Sets the ID number to activate the Remoto control unit to upload and download firmware	From 000 (no remote control) to 250	000
D	Set Min	Sets the minimum level of the output	From 000 to 9999	---
E	Exit	Exits from hidden menus		---

23. DMX CHARTS

23.1 DMX chart 1 (16 bit dimmer and strobe disabled)

This DMX chart refers to the followspot set at default parameters.

DMX Channel	Function	Type of Control	Effect	Decimal			Percentage		
1	Master Dimmer	Proportional	Adjusts luminous output intensity from 0 to 100%	0	-	255	0%	-	100%
Projector: Astro 600W White			Table name: DMX512 Functions chart 1 (default)	Issue: 1			Date: 13/11/2019		

23.2 DMX chart 2 (16 bit dimmer enable, strobe disabled)

This DMX chart refers to the followspot set with 16 bits resolution (See chapter 17.3 of this user guide).

DMX Channel	Function	Type of Control	Effect	Decimal			Percentage		
1	Master Dimmer	Proportional	Adjusts luminous output intensity from 0 to 100%	0	-	255	0%	-	100%
2	Dimmer Fine	Proportional	Fine dimmer control 16 bit	0	-	255	0%	-	100%
Projector: Astro 600W White			Table name: DMX512 Functions chart 2 (16 bits)	Issue: 1			Date: 13/11/2019		

23.3 DMX chart 3 (Strobe function enable, 8 bit dimmer)

This DMX chart refers to the followspot set with strobe function active (See chapter 17.5 of this user guide).

DMX Channel	Function	Type of Control	Effect	Decimal			Percentage		
1	Master Dimmer	Proportional	Adjusts luminous output intensity from 0 to 100%	0	-	255	0%	-	100%
2	Spare Channel	Step	No effect	0	-	255	0%	-	100%
3	Strobe	Step	Open	0	-	20	0%	-	8%
		Step	Strobe speed 1 (minimum frequency)	21	-	40	9%	-	15%
		Step	Strobe speed 2	41	-	60	16%	-	24%
		Step	Strobe speed 3	61	-	80	25%	-	31%
		Step	Strobe speed 4	81	-	100	32%	-	39%
		Step	Strobe speed 5	101	-	120	40%	-	47%
		Step	Strobe speed 6	121	-	140	48%	-	55%
		Step	Strobe speed 7	141	-	160	56%	-	63%
		Step	Strobe speed 8	161	-	180	64%	-	71%
		Step	Strobe speed 9	181	-	200	72%	-	78%
		Step	Strobe speed 10 (maximum frequency)	201	-	220	79%	-	86%
Step	Closed	221	-	255	87%	-	100%		
Projector: Astro 600W White			Table name: DMX512 Functions chart 3 (Strobe)	Issue: 1			Date: 13/11/2019		

23.4 DMX chart 4 (16 bits dimmer and Strobe enabled)

This DMX chart refers to the followspot set with 16 bits resolution and strobe function active (See chapter 17.3 and 17.5 of this user guide).

DMX Channel	Function	Type of Control	Effect	Decimal			Percentage		
					-			-	
1	Master Dimmer	Proportional	Adjusts luminous output intensity from 0 to 100%	0	-	255	0%	-	100%
2	Dimmer Fine	Proportional	Fine dimmer control 16 bit	0	-	255	0%	-	100%
3	Strobe	Step	Open	0	-	20	0%	-	8%
		Step	Strobe speed 1 (minimum frequency)	21	-	40	9%	-	15%
		Step	Strobe speed 2	41	-	60	16%	-	24%
		Step	Strobe speed 3	61	-	80	25%	-	31%
		Step	Strobe speed 4	81	-	100	32%	-	39%
		Step	Strobe speed 5	101	-	120	40%	-	47%
		Step	Strobe speed 6	121	-	140	48%	-	55%
		Step	Strobe speed 7	141	-	160	56%	-	63%
		Step	Strobe speed 8	161	-	180	64%	-	71%
		Step	Strobe speed 9	181	-	200	72%	-	78%
		Step	Strobe speed 10 (maximum frequency)	201	-	220	79%	-	86%
		Step	Closed	221	-	255	87%	-	100%
Projector: Astro 600W White			Table name: DMX512 Functions chart 4 (16 bits + Strobe)			Issue: 1		Date: 13/11/2019	

Luci della Ribalta srl reserves the right to modify the present document without prior notice.



CERTIFICATO DI CONFORMITA' - CERTIFICATE OF CONFORMITY
KONFORMITAETSERKLAREUNG - CERTIFICAT DE CONFORMITE'
CERTIFICADO DE CONFORMIDAD

I Noi sottoscritti dichiariamo, sotto la nostra completa responsabilità, che i prodotti:
EN We hereby declare, under our own responsibility, that the products listed here below:
D Wir beglaubigen, daß die nachfolgend genannten Produkte:
F Nous certifions, sous notre responsabilité, que le produits mentionnés ci-dessous:
ES Los que subscriben declaran, bajo su responsabilidad, que los productos aquí listados:

ASTRO 600 LED LUMINAIRES
Standard models and all their variants

I sono conformi alle seguenti normative:
EN conform to to the following standards:
D entsprechen den nachfolgen angeführten Normen:
F sont conformes aux normes ci-après:
ES cumplen de hecho con las siguientes normas:

EN IEC 55015:2019	LIMITS AND METHODS OF MEASUREMENTS OF RADIO DISTURBANCE CHARACTERISTICS OF ELECTRICAL LIGHTING AND SIMILAR EQUIPMENT
EN 61547: 2020	EQUIPMENT FOR GENERAL LIGHTING PURPOSES. EMC IMMUNITY REQUIREMENTS
EN 61000-3-2: 2019	ELECTROMAGNETIC COMPATIBILITY (EMC). PARTS 3-2: LIMITS -LIMITS FOR HARMONIC CURRENT EMISSIONS (EQUIPMENT INPUT CURRENT UP TO AND INCLUDING 16 A PER PHASE) CLASS C
EN 61000-3-3: 2013+A1: 2019	ELECTROMAGNETIC COMPATIBILITY (EMC) - PART 3-3: LIMITS - LIMITATION OF VOLTAGE CHANGES, VOLTAGE FLUCTUATIONS AND FLICKER IN PUBLIC LOW-VOLTAGE SUPPLY SYSTEMS, FOR EQUIPMENT WITH RATED CURRENT \leq 16 A PER PHASE AND NOT SUBJECT TO CONDITIONAL CONNECTION
EN IEC 60598-1: 2021+A11: 2022	SPECIFIES GENERAL REQUIREMENTS FOR LUMINAIRES. INCORPORATING ELECTRIC LIGHT SOURCES FOR OPERATIONS FROM SUPPLY VOLTAGES UP TO 1 000 V.
EN IEC 60598-2-17: 2018	SPECIFIES REQUIREMENTS FOR STAGES, TELEVISION, FILM AND PHOTGRAPHIC STUDIO LUMINAIRES (INCLUDING SPOT AND FLOODLIGHTING PROJECTORS) FOR USE OUTDOORS AND INDOORS, WITH ELECTRIC LIGHT SOURCES ON SUPPLY VOLTAGES NOT EXCEEDING 1 000 V.
EN 62493: 2015	APPLIES TO THE ASSESSMENT OF LIGHTING EQUIPMENT RELATED TO HUMAN EXPOSURE TO ELECTROMAGNETIC FIELD
EN 63000: 2018	TECHNICAL DOCUMENTATION FOR ASSESSMENT OF ELECTRICAL AND ELECTRONIC PRODUCTS WITH RESPECT TO THE RESTRICTION OF HAZARDOUS SUBSTANCES

FOLLOWING THE EU DIRECTIVE OF THE EUROPEAN PARLAMENT AND THE COUNCIL OF THE EUROPEAN UNION:

- 2014/30/EU ELECTROMAGNETIC COMPATIBILITY (EMC)
- 2014/35/EU EU LOW VOLTAGE (LVD)
- 2011/65/UE
- 2009/125/CE
- 2019/2020 + 2021/341

In faith, Lisa Papi, President

Lucidella Ribalta srl

Via berna 14, 46042 castel goffredo mn italy
tel +39 0376 771777 fax +39 0376 772140 email info@ldr.it
web www.ldr.it Riva 01815640204 c.i.so IT01815640204

Lisa Papi

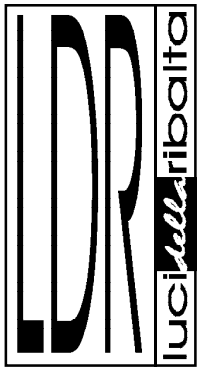

modulo di reclamo - complaint form
Reklamationsformular - formulaire de réclamation -
hoja de reclamaciones

email: info@ldr.it

Azienda ed Indirizzo - Company's name and address - Firmenname und Adresse - Nom et adresse -
Nombre y dirección

Nome del rivenditore da cui il prodotto è stato acquistato - Name of the dealer where you have purchased
the product - Namen der Firma, die Ihnen das Produkt verkauft hat - Nom de la société qui vous a vendu ce
produit - Nombre de la compañía donde han comprado el producto:

- | | | | |
|---------------------|--------------------------|-----------|---------------------------|
| Prodotto difettoso | <input type="checkbox"/> | A01607270 | Astro 600W 6000K Tropical |
| Faulty product | <input type="checkbox"/> | K01607270 | Astro 600W 6000K kit |
| Defekte s Produkt | <input type="checkbox"/> | | Tropical |
| Produit défectueux | <input type="checkbox"/> | | DMX512+RDM |
| Producto defectuoso | <input type="checkbox"/> | | |
| | <input type="checkbox"/> | | |

Descrizione del problema /Problem found/Beschreibung des Defekts/Description du défaut/Descripción del problema

Data d'acquisto - Date of purchase - Kaufdatum - Date de l'achat - Fecha de compra _____

Si prega di allegare prova d'acquisto - Please attach copy of purchase invoice - Bitte Kaufnachweis beilegen -
Veuillez joindre une quittance d'achat - Les rogamos incluyan l' copia de la factura de compra.

Nome e qualifica - Name and position - Name und Funktion - Nom et fonction - Nombre y cargo

Data - Date - Datum - Date - Fecha _____

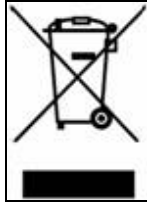

IT

Direttiva 2002/96/CE (Rifiuti di Apparecchiature Elettriche ed Elettroniche - RAEE):
informazioni agli utenti: ai sensi dell'art. 13 del Decreto Legislativo 25 luglio 2005, n. 151 "Attuazione delle Direttive 2002/95/CE, 2002/96/CE e 2003/108/CE, relative alla riduzione dell'uso di sostanze pericolose nelle apparecchiature elettriche ed elettroniche, nonché allo smaltimento dei rifiuti" questo prodotto è conforme.

Il simbolo del cassonetto barrato riportato sull'apparecchiatura o sulla sua confezione indica che il prodotto alla fine della propria vita utile deve essere raccolto separatamente dagli altri rifiuti. L'utente dovrà, pertanto, conferire l'Apparecchiatura giunta a fine vita agli idonei centri di raccolta differenziata dei Rifiuti Elettronici ed Elettrotecnici, oppure riconsegnarla al rivenditore al momento dell'acquisto di una nuova apparecchiatura di tipo equivalente, in ragione di uno a uno. L'adeguata raccolta differenziata per l'avvio successivo dell'apparecchiatura dismessa al riciclaggio, al trattamento ed allo smaltimento ambientalmente compatibile contribuisce ad evitare possibili effetti negativi sull'ambiente e sulla salute e favorisce il reimpiego e/o riciclo dei materiali di cui è composta l'apparecchiatura. Lo smaltimento abusivo del prodotto da parte dell'utente comporta l'applicazione delle sanzioni amministrative previste dalla normativa vigente.

ES

Directiva 2002/96/EC (Residuos de aparatos eléctricos y electrónicos - RAEE):
Información para el usuario.

Este producto es conforme con la Directiva EU 2002/96/CE. El símbolo de la papelera barrada situado sobre el aparato indica que este producto, al final de su vida útil, debe ser tratado separadamente de los residuos domésticos. El usuario es responsable de la entrega del aparato al final de su vida útil a los centros de recogida autorizados. El adecuado proceso de recogida diferenciada permite dirigir el aparato desechado al reciclaje, a su tratamiento y a su desmantelamiento de una forma compatible con el medio ambiente, contribuyendo a evitar los posibles efectos negativos sobre el ambiente y la salud, favoreciendo el reciclaje de los materiales de los que está compuesto el producto. Para información más detallada inherente a los sistemas de recogida disponibles, dirigirse al servicio local de recogida o al establecimiento donde se adquirió el producto.

FR

Directive 2002/96/CE (Déchets d'équipements électriques et électroniques - DEEE):
informations aux utilisateurs.

Ce produit est conforme à la Directive ED 2002/96/CE. Le symbole de la corbeille barrée reporté sur l'appareil indique que ce dernier doit être éliminé à part lorsqu'il n'est plus utilisable et non pas avec les ordures ménagères. L'utilisateur a la responsabilité de porter l'appareil hors d'usage à un centre de ramassage spécialisé. Le tri approprié des déchets permet d'acheminer l'appareil vers le recyclage, le traitement et l'élimination de façon écologiquement compatible. Il contribue à éviter les effets négatifs possibles sur l'environnement et sur la santé, tout en favorisant le recyclage des matériaux dont est constitué le produit. Pour avoir des informations plus détaillées sur les systèmes de ramassage disponibles, s'adresser au service local d'élimination des déchets ou au revendeur.

DE

Richtlinie 2002/96/EU (Elektro- und Elektronik-Altgeräte - WEEE):
Benutzerinformationen.

Dieses Produkt entspricht der EU Richtlinie 2002/96/EU. Das Symbol des auf dem Gerät dargestellten, durchgestrichenen Korbes gibt an, dass das Produkt am Ende seiner Nutzungsdauer gesondert vom Hausmüll zu behandeln ist. Am Ende der Nutzungsdauer ist der Benutzer für die Überantwortung des Geräts an geeignete Sammelstellen verantwortlich. Die angemessene, getrennte Müllsammmlung zwecks umweltkompatibler Behandlung und Entsorgung für den anschließenden Recycling beginn des nicht mehr verwendeten Geräts trägt zur Vermeidung möglicher schädlicher Wirkungen auf Umwelt und Gesundheit bei und begünstigt das Recycling der Materialien, aus denen das Produkt zusammengesetzt ist. Für nähere Informationen bezüglich der zur Verfügung stehenden Sammelsysteme, wenden Sie sich bitte an den örtlichen Müllentsorgungsdienst oder an das Geschäft, in dem der Kauf getätigt worden ist.

UK

Directive 2002/96/EC (Waste Electrical and Electronic Equipment - WEEE):
information for users.

This product complies with EU Directive 2002/96/EC. The crossed-out wastebasket symbol on the appliance means that at the end of its useful lifespan, the product must be disposed of separately from ordinary household wastes. The user is responsible for delivering the appliance to an appropriate collection facility at the end of its useful lifespan. Appropriate separate collection to permit recycling, treatment and environmentally compatible disposal helps prevent negative impact on the environment and human health and promotes recycling of the materials making up the product. For more information on available collection facilities, contact your local waste collection service or the shop where you bought this appliance.

NL

Richtlijn 2002/96/EG (Afgedankte Elektrische en Elektronische Apparaten - AEEA):
informatie voor de gebruikers.

Dit product voldoet aan de richtlijn EU 2002/96/EG. Het symbool van de vuilnisbak met een streep erdoor, dat op het apparaat staat, geeft aan dat het product, wanneer het wordt afgedankt, niet met het huisvuil kan worden meegegeven. Het is de verantwoordelijkheid van de gebruiker het product, op het moment dat dit wordt afgedankt, in te leveren bij een centrum voor gescheiden afvalverwerking. Een correcte gescheiden afvalverwerking, die gericht is op de recycling van het afgedankte product en die een milieuvriendelijke behandeling en vernietiging mogelijk maakt, draagt ertoe bij mogelijk negatieve effecten op het milieu en op de gezondheid te voorkomen en bevordert het hergebruik van de materialen waaruit het product bestaat. Voor meer gedetailleerde informatie met betrekking tot de voorhanden zijnde afvalverwerkingsystemen dient u zich te wenden tot de plaatselijke vuilnisdienst of tot de winkelier waar u het product heeft gekocht.

PT

Directiva 2002/96/CE (Resíduos de equipamentos eléctricos e electrónicos REEE):
informações para os utilizadores.

Este produto é conforme à Directiva EU 2002/96/CE. O símbolo do cesto barrado marcado no aparelho indica que o produto, no fim da própria vida útil, deve ser tratado separadamente do lixo doméstico. O utilizador é responsável pela entrega do aparelho, no fim da vida do mesmo, às apropriadas estruturas de recolha. A adequada recolha diferenciada para o encaminhamento sucessivo do aparelho à reciclagem, ao tratamento e ao escoamento ambientalmente compatível, contribui para evitar possíveis efeitos negativos sobre o ambiente e a saúde e favorece a reciclagem dos materiais que compõem o produto. Para informações mais detalhadas inerentes aos sistemas de recolha disponíveis, dirija-se ao serviço

local de escoamento de resíduos, ou a loja na qual efectuou a compra.

NO

WEEE-symbolet (Waste Electrical and Electronic Equipment).

Bruken av WEEE-symbolet indikerer at dette produktet ikke kan behandles som husholdningsavfall. Du vil bidra til å beskytte miljøet ved å sørge for at dette produktet blir avhendet på en forsvarlig måte. Ta kontakt med kommunale myndigheter, renovasjonsselskapet der du bor eller forretningen hvor du kjøpte produktet for å få mer informasjon om resirkulering av dette produktet.

S

Symbol för avfall från elektrisk och elektronisk utrustning (WEEE).

Märkning med WEEE-symbolen visar att produkten inte får behandlas som hushållsavfall. Genom att slänga den här produkten på rätt sätt bidrar du till att skydda miljön. Mer information om återvinning av produkten kan du få av de lokala myndigheterna, din renhållningsservice eller i affären där du köpte produkten.

FI

WEEE-merkintä (sähkö- ja elektroniikkalaiteromu).

WEEE-merkintä osoittaa, että tätä tuotetta ei voi käsitellä kotitalousjätteen tavoin. Kun huolehdit tämän tuotteen asianmukaisesta hävittämisestä, autat suojelemaan ympäristöä. Lisätietoja tämän tuotteen kierrättämisestä saat paikallisviranomaisilta, jätehuoltoyhtiöltäsi tai myymälästä josta ostit tämän tuotteen.

DK

Symbol for affald af elektrisk og elektronisk udstyr (WEEE)

Brugen af WEEE-symbolet betyder, at dette produkt ikke må behandles som husholdningsaffald. Ved at sørge for korrekt bortskaffelse af produktet medvirker du til at beskytte miljøet. Du kan få flere oplysninger om genbrug af dette produkt hos de lokale myndigheder, dit renovationselskab eller i forretningen, hvor du har købt produktet.

HU

Hulladék elektromos vagy elektronikus készüléket jelölő szimbólum.

Ez a szimbólum azt jelöli, hogy a terméket nem szabad háztartási hulladékként kezelni. A hulladékká vált termék megfelelő elhelyezésével hozzájárul a környezet védelméhez. A termék újrafelhasználásával kapcsolatban a helyi szerveknél háztartási hulladékokat elszállító vállalatnál vagy a terméket értékesítő üzletben tájékozódhat.

CZ

Symbol pro odpadní elektrický a elektronický materiál (WEEE).

Použití symbolu WEEE označuje, že tento produkt ne lze likvidovat jako domovní odpad. Správnou likvidací tohoto produktu přispějete k ochraně životního prostředí. Podrobnější informace o likvidaci tohoto produktu vám poskytne místní úřady, společnost pro likvidaci komunálního odpadu nebo obchod, kde jste zboží zakoupili.

